

Design and Construction of the Triple GEM Detector for TOTEM

M. Bozzo, M. Oriunno, L. Ropelewski, F. Sauli, R. Orava, J. Ojala, K. Kurvinen, R. Lauhakangas, J. Heino, W. Snoeys, F. Ferro, M. Van Stenis and E. David

Abstract-- We describe the design and construction of the first triple-GEM chamber prototypes for the TOTEM detector at CERN LHC. The chambers are semicircular, with an inner and outer radius of the active area of about 40 and 150 mm; six to eight detectors will be mounted on each arm. Each chamber has analogue readout of the charge on concentric circular strips, at 400 μm pitch, to obtain the radial coordinates, and about 1000 pads of sizes between 3x3 and 7x7 mm^2 with digital readout, used to generate the triggering in combination with the other chambers.

I. INTRODUCTION

TOTEM is a forward physics experiment at the LHC [1]. Its detectors will be installed into the CMS environment at the intersection point I5 (Fig. 1). The TOTEM experiment will measure the total pp cross section and study elastic scattering and diffractive dissociation at the LHC. The design objectives include measurements 1) of the total cross-section with an absolute error of 1mb, 2) of elastic proton scattering over a wide range in momentum transfer up to $-t \approx 10 \text{ GeV}^2$, and 3) of diffractive dissociation, including single, double and central diffraction topologies using the forward inelastic detectors in combination with one of the large LHC detectors.

TOTEM has to measure the inelastic pp interaction with adequate acceptance in the forward region. Two tracking telescopes, T1 and T2, installed on each side of the IP in a manner compatible with the CMS detector, will provide this coverage. The T1 telescope will be placed in the CMS endcaps, while T2 will be in the shielding behind the CMS Hadronic Forward (HF) calorimeter. T1 and T2 add charged particle tracking and trigger capabilities to the CMS experiment over a rapidity interval $3 \leq \eta \leq 6.6$. The combined coverage of CMS and TOTEM represents a largest acceptance detector ever built at a hadron collider (Fig. 2).

While the measurement of the total cross-section and the elastic scattering can be performed using only the TOTEM detectors, the integration of TOTEM into the general purpose CMS detector offers the prospect of more detailed studies of diffractive events.

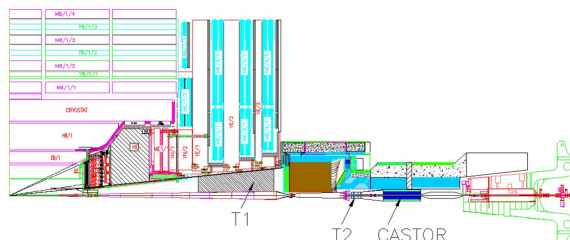

Fig. 1. The TOTEM detectors are installed in the CMS forward region.

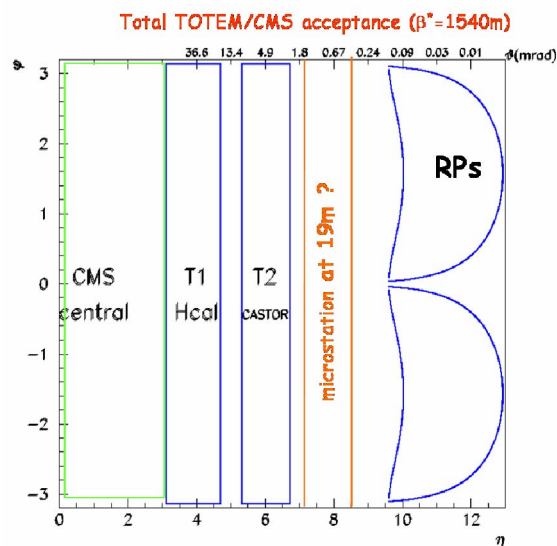

Fig. 2. The acceptance of a common CMS/TOTEM experiment in the azimuth-pseudorapidity plane.

II. T2 TELESCOPE

The T2 telescope is located in the forward region of the CMS experiment at $z = 13560 \text{ mm}$ from IP5. It is integrated inside the plug of the HF calorimeter, very close to the vacuum chamber covering a rapidity acceptance range $5.3 \leq \eta \leq 6.6$. The T2 must be constructed as two separate halves since it will be installed around the vacuum chamber, which is already in place. The charged particle densities are estimated to be a few $10^6 \text{ cm}^{-2} \text{ s}^{-1}$ at luminosities of $L \sim 10^{33} \text{ cm}^{-2} \text{ s}^{-1}$. The present T2

Manuscript received November 1, 2004.

M.Bozzo and F. Ferro are with Department of Physics and INFN, Genoa, Italy (email: marco.bozzo@cern.ch; fabrizio.ferro@cern.ch)

M.Oriunno, L.Ropelewski, F.Sauli, W.Snoeys, M.Van Stenis and E.David are with PH department, CERN, Geneva, CH12-11 Switzerland (email: marco.oriunno@cern.ch; leszek.ropelewski@cern.ch; fabio.sauli@cern.ch; walter.snoeys@cern.ch; miranda.van.stenis@cern.ch; eric.david@cern.ch)

R.Orava, J.Ojala, K.Kurvinen, R.Lauhakangas and J.Heino are with Helsinki Institute of Physics, P.O.Box 64, Gustaf Hällstöminkatu 2, FIN-00014 University of Helsinki, Finland (email: risto.orava@helsinki.fi; jukka.p.ojala@helsinki.fi; kari.kurvinen@helsinki.fi; rauno.lauhakangas@helsinki.fi; jouni.heino@helsinki.fi)

telescope design is based on utilisation of gaseous electron multipliers (GEM), thanks to their large active area, good position resolution, excellent rate capability and radiation hardness characteristics.

The T2 telescope will be constructed of ten GEM planes on the both sides of CMS. The detector planes are semi-circular in shape, with an inner radius matching the beam pipe. To avoid dead zones the angular coverage of these half circles is more than 180, and is hence slightly overlapping (Fig. 3). The detector planes give both tracking and triggering information.

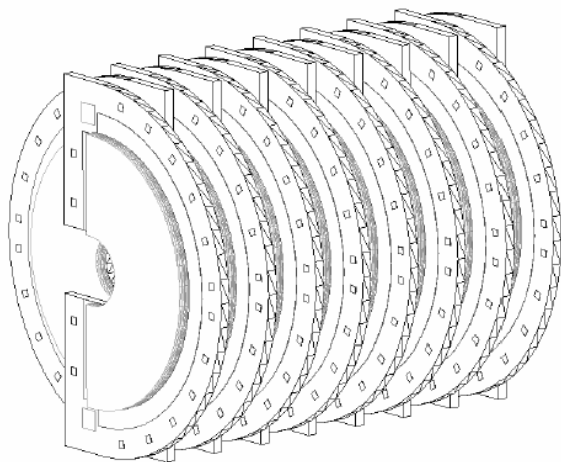

Fig. 3. The GEM detectors in the TOTEM T2 telescope.

III. TRIPLE GEM DETECTOR

The GEM design used in the COMPASS experiment was selected as a baseline for the T2 GEM [2]. The GEM foil consists of thin copper clad polyimide foil of 50 microns, with copper layers of 5 microns on both sides, chemically perforated with a large number of holes of around 70 microns.

The foils have been manufactured by the CERN-EST-DEM workshop. Three GEM foils are utilized to reduce sparking probabilities. A safe gas amplification of order 10^4 is easily achieved by using multiple foils. To reduce both the energy and the punch-through propagation probability of discharges, the other copper electrode of the foil is subdivided in four semi-circular sections, which are separately connected externally to the voltage supply through high voltage resistors (Fig. 4). The innermost section may be individually powered, offering a switching-off feature during bad beam conditions.

Honeycomb structures covered with thin fibreglass reinforced polyester/epoxy foils are used as supporting structures on both sides of the GEM. The GEM foils are supported by frames with thin spacers, which are also manufactured from the similar fibreglass epoxy (Figs. 5 and 6).

The readout anode is constructed from a three layer printed circuit board, which contain 256 concentric strips measuring the radial coordinates of traversing particles and a matrix of 1536 pads delivering the trigger information. The strips are 80 microns wide with pitch of 400 microns. Signals from the

strips are collected by analog readout chips, which are installed at the end of the strips on the supporting plate. To improve the occupancy of the strips, division of the strips to multiple sections is considered. The pads are arranged to 64 sectors, each containing 24 pads. The size of them is increasing from $2 \times 2 \text{ mm}^2$ to $7 \times 7 \text{ mm}^2$ from the inner to outer circle. Signals from the pads are transferred by vias and strips on the backside of the board to the outer edge, where digital readout electronics is bonded (Figs. 7 - 9).

The analog charge pulses from the strips are read by two APV25 preamplifier chip, each containing 128 input channels. If the strips will be divided into short sections, more readout chips are needed, consequently. The trigger information from the pads is collected with twelve VFAT chips, which have fast-OR outputs.

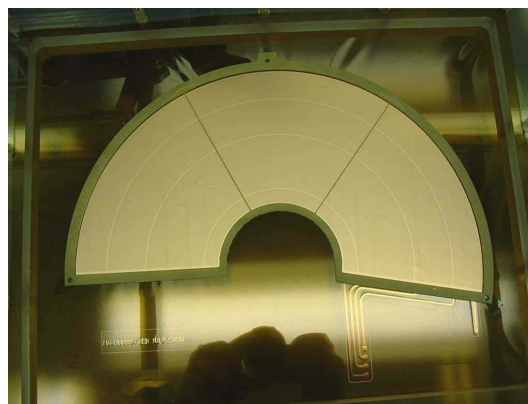

Fig. 4. The GEM foil glued on the frame.



Fig. 5. The spacing between the various components in the triple GEM.

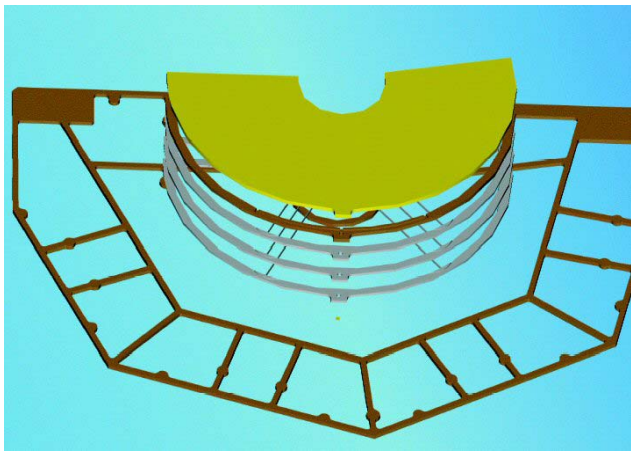

Fig. 6. The structure of the support frames of the GEM foils, the drift electrode and the readout board.

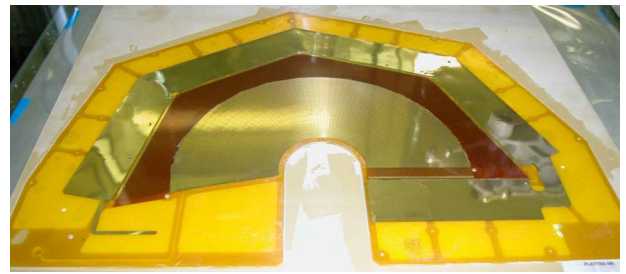

Fig. 8. The readout board glued on the support.

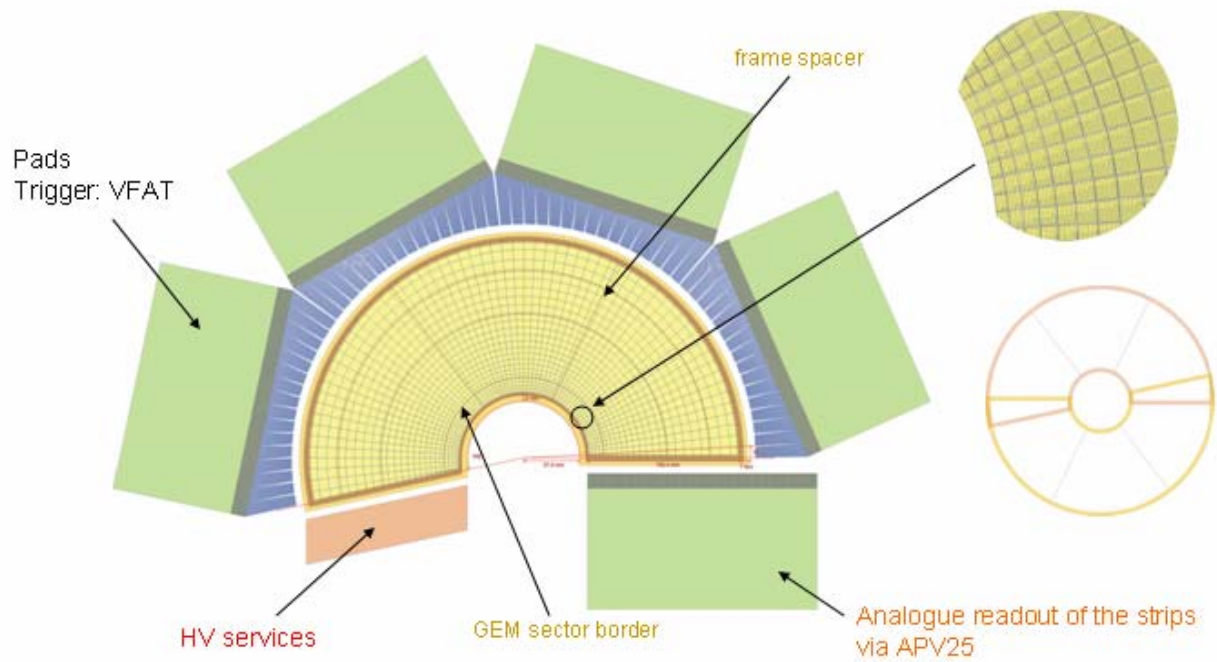

Fig. 7. The readout board structure.



Fig. 9. The first prototype of the GEM assembled for a beam test.

REFERENCES

- [1] V. Avati, V. Bergholm, V. Boccone, M. Bozzo, M. Buenerd, A. Buzzo, R. Cereseto, S. Cuneo, C. Da Viá, M. Deile, K. Eggert, F. Ferro, J.P. Guillaud, J. Hasi, F. Haug, R. Herzog, P. Jarron, J. Kalliopuska, A. Kiiskinen, K. Kurvinen, A. Kok, W. Kundrat, R. Lauhakangas, M. Lokajichok, D. Macina, M. Macri, T. Mäki, S. Minutoli, A. Morelli, P. Musico, M. Negri, E. Noschis, F. Oljemark, R. Orava, M. Oriunno, K. Österberg, V.G. Palmieri, K. Protasov, R. Puppo, D. Rebreyend, R. Rubischer, G. Ruggiero, H. Saarikko, A. Santroni, G. Sanguinetti, G. Sette, W. Snoeys, S. Tapprogge, A. Toppinen, A. Verdier, S. Watts and E. Wobst, "The TOTEM experiment" *Eur Phys J C.*, vol. 34, pp. 255-268, 1997.
- [2] C. Altunbas, M. Capeans, K. Dehmelt, J. Ehlers, J. Friedrich, I. Konorov, A. Gandi, S. Kappler, B. Ketzer, R. De Oliveira, S. Paul, A. Placci, L. Ropelewski, F. Sauli, F. Simon and M. van Stenis "Construction, test and commissioning of the triple-gem tracking detector for compass", *Nucl. Inst. Meth.*, vol A 490, pp. 117-203, 2002.